



## HPI-25VTC-02

Hendrix Vise Top pin insulators incorporate a clamping mechanism in the insulator to provide quick and easy conductor installation without the need for additional tie products. When used with the VTST-1 Stringing Tool, conductors can be installed without separate stringing blocks, significantly reducing installation costs.

The HPI-25VTC-02 is designed with composite clamping inserts suitable for use with bare aluminum, copper eliminating dissimilar metals galvanic reactions and with covered conductors. The composite is chemically inert and does not deteriorate by weather/UV or contamination. It also offers consistent and repetitive gripping across all conductor types. The HPI-25VTC-02 has a standard ANSI 1-3/8" thread size and is a direct replacement for medium-voltage pin insulators.

- Exceeds ANSI electrical and mechanical requirements
- Breakaway bolt rings ensure proper conductor clamping
- Resistant to impact damage, breakage and vandalism
- Made from UV stabilized polyethylene
- Offers SKU reduction
- Made in USA

## PRODUCT DATA

Characteristic	ANSI C29.5 Class 56-1	HPI-25VTC-02
<b>DIMENSIONS</b>		
Leakage distance (in)	13	15.7
Dry-arc distance (in)	7	9.3
<sup>[1]</sup> Pin-hole diameter (in)	1-3/8	1-3/8
<b>MECHANICAL VALUES</b>		
<sup>[2]</sup> Cantilever strength (lbs)	2500	>3000
<b>ELECTRICAL VALUES</b>		
Typical application (kV)		25
Flashover voltage, 60 Hz Dry (kV)	95	97
Flashover voltage, 60 Hz Wet (kV)	60	53
Impulse Flashover – Positive (kV)	150	153
Impulse Flashover – Negative (kV)	190	190
Low frequency Puncture (kV)	130	220
<b>OTHER</b>		
Max. Conductor Diameter (in)		1.75
Part Weight (lbs)		2.6
Max Continuous Conductor Temp (°C)		120

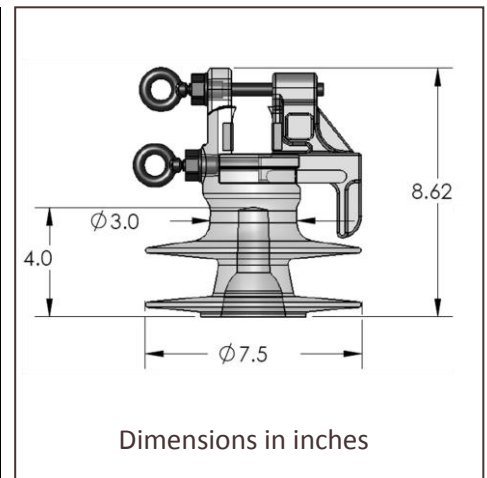

Notes: [1] Other pin-hole diameters and thread configurations are available  
 [2] Cantilever strength refers to side neck loading